

CREALITY

CREALITY BOX 2.0 User Manual

Shenzhen Creality Technology Co., Ltd

Parts list

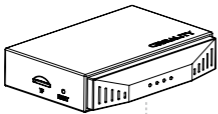

CREALITY BOX 2.0 *1



Converter *1



USB cable*2



User manual*1



Certification of approval *1



TF card*1 (Optional)

Parts list

CREALITY BOX 2.0 x1 USB cable*2 Converter *1 User manual*1
Certificate of approval *1 TF card*1 (Optional)

Machine introduction

CREALITY BOX 2.0

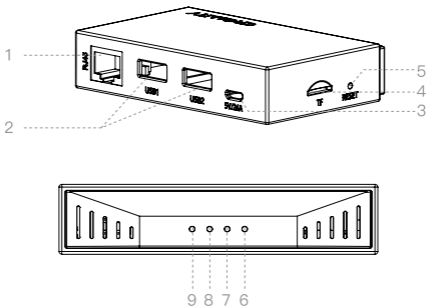

- | | |
|-----------------------------|---|
| 1 RJ45 network port | 6 Yellow light:
WIFI working status |
| 2 Connect printer/camera | 7 Blue light:
Ethernet indicator |
| 3 Micro USB power interface | 8 Green light:
Cloud/distribution
network indicator |
| 4 TF card connector | 9 Red indicator:
TF card indicator |
| 5 Reset button | |

Assembly procedure

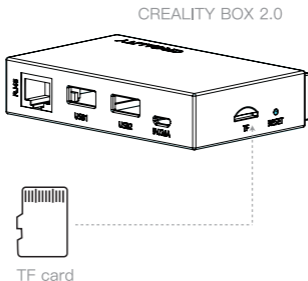

- 1.The product is working when the yellow indicator flashes.
- 2.The connection is successful when the green indicator flashes, but it is failed when the indicator keeps on.
3. The TF card is not inserted when the red indicator keeps on.

1.Insert the TF card (FAT32/exFAT format) into the TF card connector of the box.

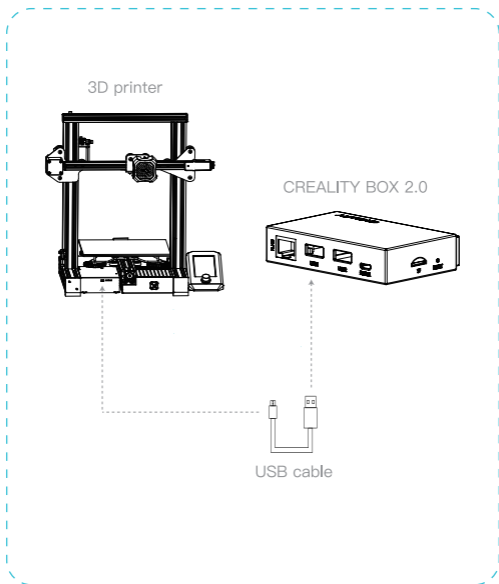

2. Connect the MINI/Micro USB port of printer and the USB1/USB2 port of the box with the USB cable equipped with the printer, and turn on.



SHENZHEN CREALITY 3D TECHNOLOGY CO.,LTD.

Add : 18F, JinXiuHongDu Building, Meilong Blvd.,
Longhua Dist., Shenzhen, China 518131

Official Website: www.creality.com Tel: +86 755-8523 4565

E-mail: info@creality.com cs@creality.com



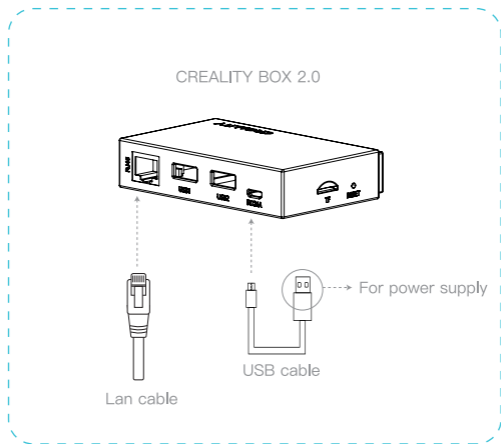

Note: The output is 5V/2.4A for the power supply. Please press and hold the reset button for more than 5s until default settings are restored, then reconnect to network through the APP “Creative Cloud”.

3.Ensure the connection successful between the port “5V/2.4A” of product and the power supply by the USB cable and turn on, and networking either Ethernet or Wireless.

Download Creativity Cloud APP



①Scan and download



②Register



③Log in



④Add device

Download the APP “Creative Cloud” by app store or scanning the QR code on the packing box, register and log in, click the “Add Device” and “Bluetooth Networking”, or Scan Code to Add” to select your device.

Network Configuration



① Select bluetooth



② Add device



③ Connect to the external WIFI

Method 1: Click "Add Device" → "Bluetooth Network Configuration" to select your device



①Scan QR Code

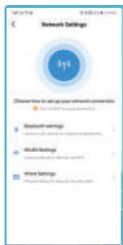

②Network settings

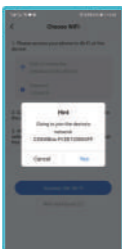

③Connect to device WIFI



④Connect to the external WIFI

Method 2: Click "Add Device" → "Scan Code to Add" to select your device

Model Printing



①Select model



②Select Printer



③Printing



④Start printing

Select model, printer, device to print through the APP after connection and online

3D Printing Industry Evangelist